

**HOLDEN OPEL ASTRA 1991-98 2**

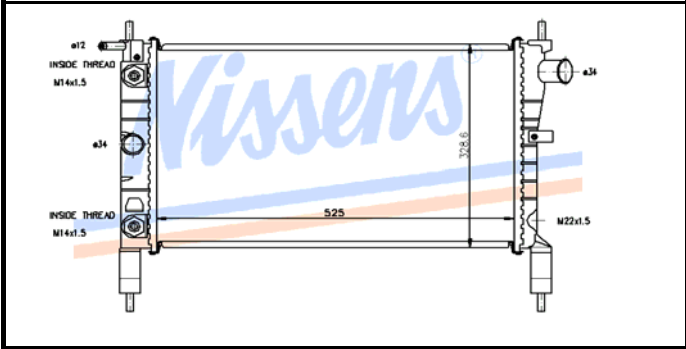

Auto	HOL2A	P/A	Man	HOL2B
Core	525X322X23		OE#	1300115/112
Remarks				

**HOLDEN OPEL ASTRA 1991-97 16**

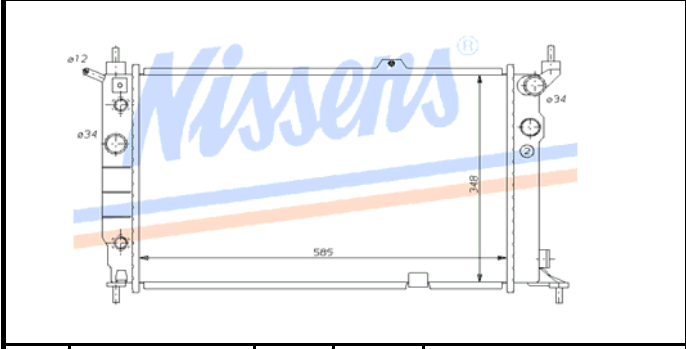

Auto	HOL16A	P/A	Man	HOL16B
Core	590X365X32		OE#	1300109/147
Remarks				

**HOLDEN OPEL ASTRA 1991-98 3**

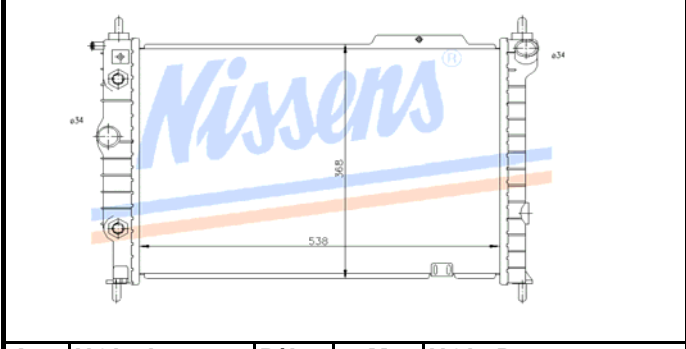

Auto	HOL3A	P/A	Man	HOL3B
Core	538X371X35		OE#	1300132/134
Remarks				

**HOLDEN OPEL ASTRA 1997-99> 11**

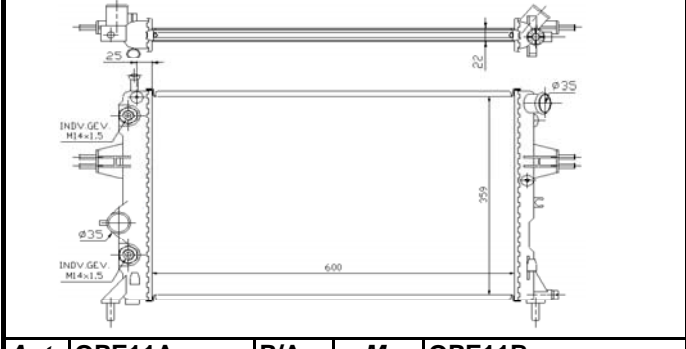

Auto	OPE11A	P/A	Man	OPE11B
Core	600X375X26		OE#	09119482 90570728
Remarks				

**HOLDEN OPEL ASTRA 1991-98 15**



Auto	HOL15A	P/A	Man	HOL15B
Core	538X368X22		OE#	1300132
Remarks				

**HOLDEN OPEL ASTRA 1993> 1**



Auto	HOL1A	P/A	Man	HOL1B
Core	530X285X17		OE#	1300150/149
Remarks				

**HOLDEN OPEL ASTRA 1994-98 7**



Auto		P/A	Man	HOL7B
Core	500X350X42		OE#	6302011
Remarks				

**HOLDEN OPEL ASTRA G 1998> 25**



Auto		P/A	Man	HOL25B
Core	540X375X22		OE#	9202496
Remarks	Engine 1.4i 1.6i 1.8i			

**HOLDEN OPEL CALIBRA 1988-95 14**

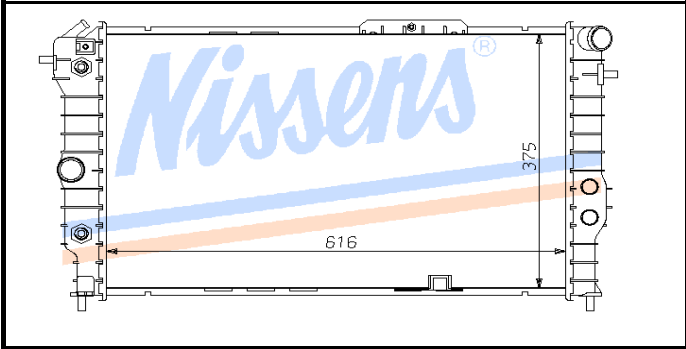

Auto	HOL14A	P/A	Man	HOL14B
Core	617X368X32		OE#	1300133 03096385
Remarks				

**HOLDEN COMMODORE VP VR VS S1 V6 9**

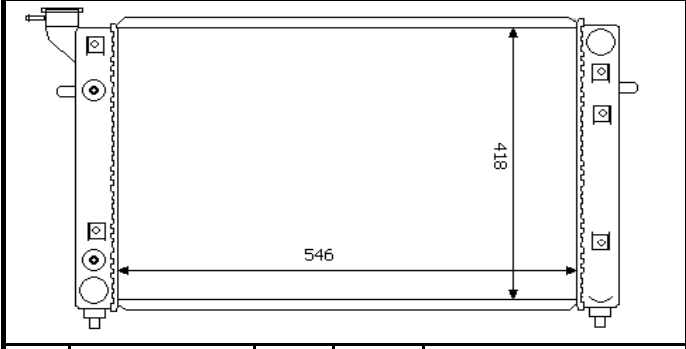

Auto	HOL9A	P/A	Man	
Core	546X418X25		OE#	Not Known
Remarks	Oilcooler push on barb connection			

**HOLDEN COMMODORE VN V6 8**

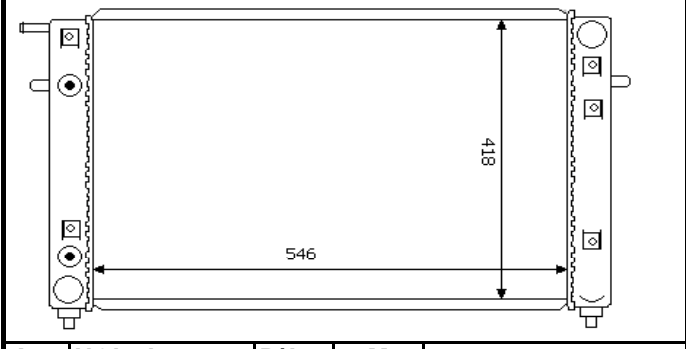

Auto	HOL8A	P/A	Man	
Core	546X418X32		OE#	Not Known
Remarks				

**HOLDEN COMMODORE VT V6 S1 28**

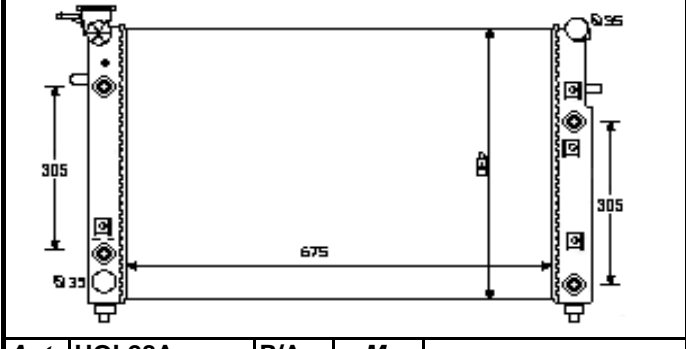

Auto	HOL28A	P/A	Man	
Core	675X427X25		OE#	Not Known
Remarks				

**HOLDEN OPEL BARINA 1993> 13**

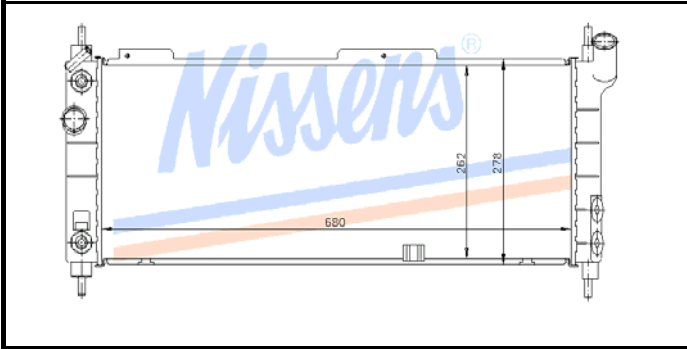

Auto	HOL13A	P/A	Man	HOL13B
Core	680X278X32		OE#	1300133 03096385
Remarks				

**HOLDEN COMMODORE VR-VS 18**

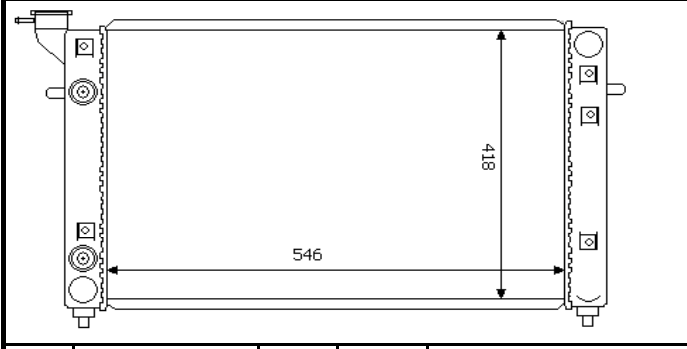

Auto	HOL18A	P/A	Man	
Core	546X418X25		OE#	Not Known
Remarks	Oilcooler threaded connection			

**HOLDEN COMMODORE VT V6 S2 19**

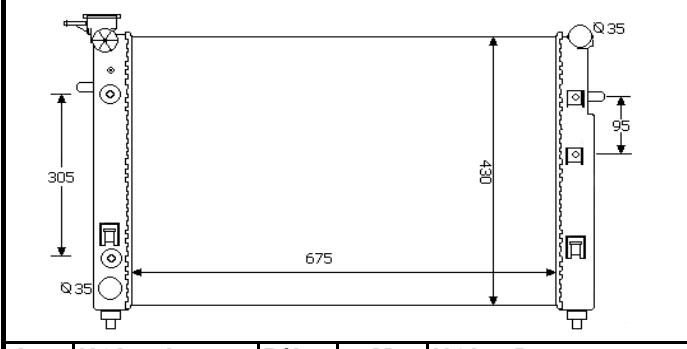

Auto	HOL19A	P/A	Man	HOL19B
Core	675X430X25		OE#	Not Known
Remarks				

**HOLDEN COMMODORE VY V6 2002 22**

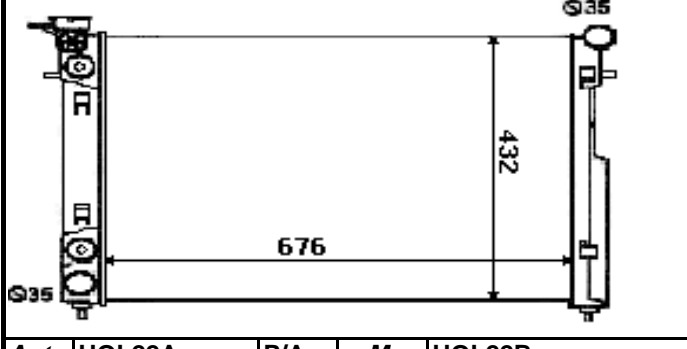

Auto	HOL22A	P/A	Man	HOL22B
Core	676X432X17/27		OE#	
Remarks	CORE17mmV/6 27mm V/8			

**HOLDEN COMMODORE VX V6 29**

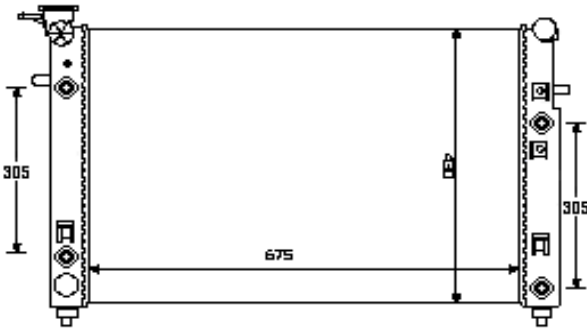

Auto	HOL29A	P/A	Man	HOL29B
Core	675X427X25		OE#	Not Known
Remarks -				

**HOLDEN COMMODORE VT V8 1997> 20**

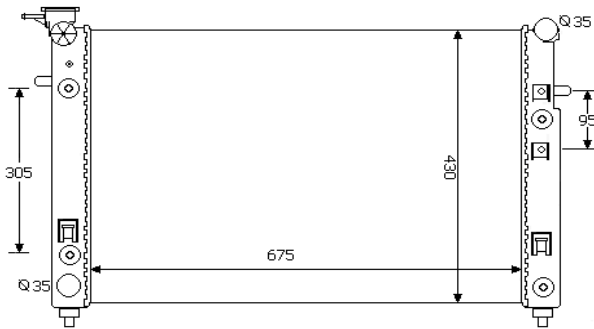

Auto	HOL20A	P/A	Man	HOL20B
Core	675X430X35		OE#	Not Known
Remarks -				

**HOLDEN COMMODORE VY V8 31**

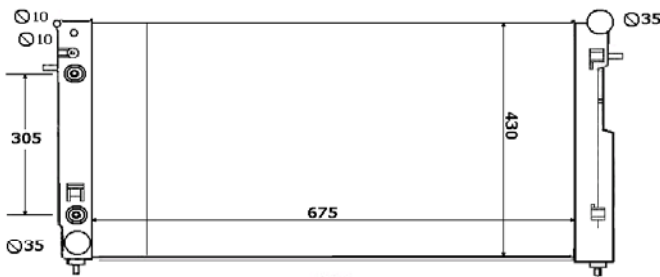

Auto	HOL31A	P/A	Man	HOL31B
Core	675X430X35		OE#	
Remarks ↓				

**HOLDEN OPEL VECTRA 1995-99 5**

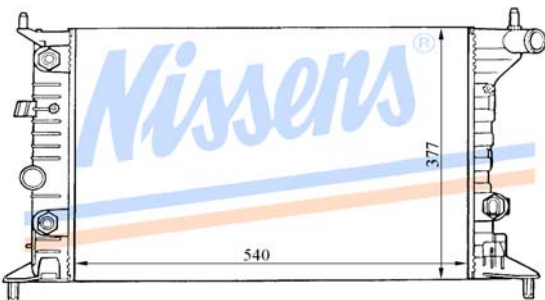

Auto	HOL5A	P/A	Man	HOL5B
Core	540X375X17		OE#	1300158 90528302
Remarks ↓				

**HOLDEN COMMODORE VT V8 27**

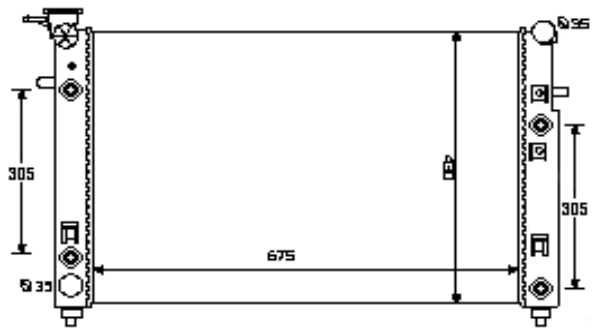

Auto	HOL27A	P/A	Man	
Core	675X416X35		OE#	
Remarks -				

**HOLDEN COMMODORE VX V8 30**

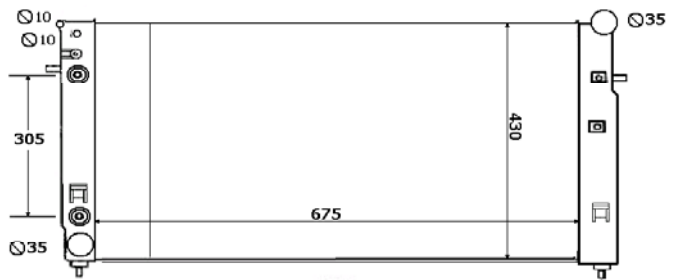

Auto	HOL30A	P/A	Man	HOL30B
Core	675X427X35		OE#	
Remarks -				

**HOLDEN OPEL VECTRA 1988-95 4**

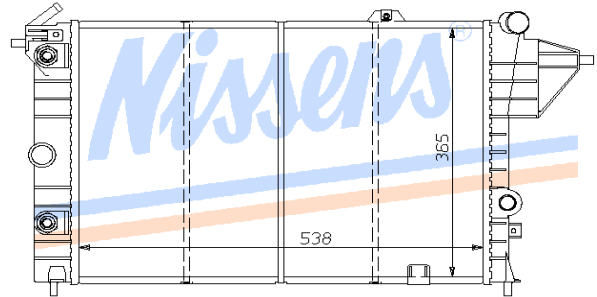

Auto	HOL4A	P/A	Man	HOL4B
Core	538X368X37		OE#	1300122 1300084
Remarks ↓				

**HOLDEN OPEL VECTRA 1988-95 10**

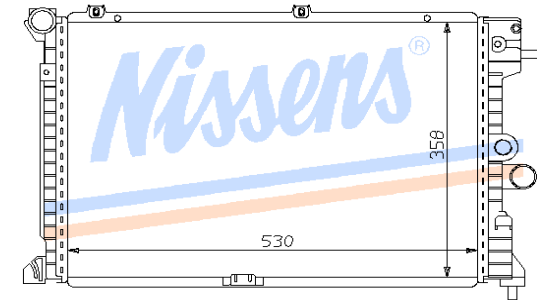

Auto		P/A	Man	OPE10B
Core	530X358X42		OE#	1300104
Remarks ↓				

**HOLDEN OPEL VECTRA B2.0 B 1995> 6**

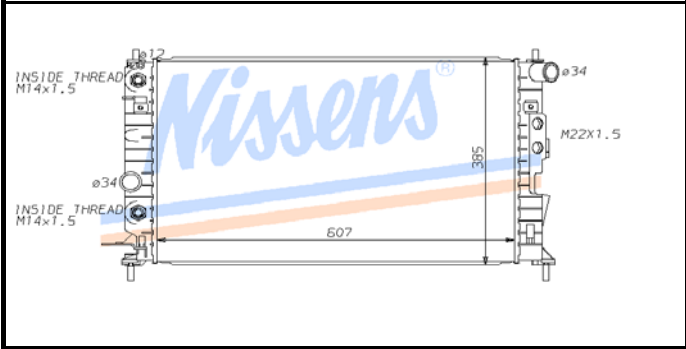

<b>Auto</b>	HOL6A	<b>P/A</b>	<b>Man</b>	HOL6B
<b>Core</b>	607X385X24		<b>OE#</b>	1300160
<b>Remarks</b> †				

**HOLDEN OPEL VECTRA 1995> 23**

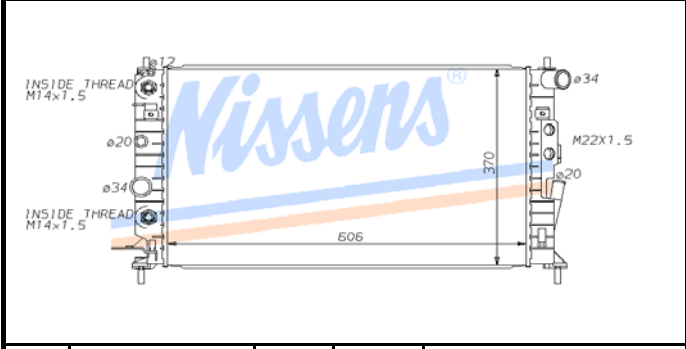

<b>Auto</b>	HOL23A	<b>P/A</b>	<b>Man</b>	
<b>Core</b>	606X370X26		<b>OE#</b>	1300161/181
<b>Remarks</b> †				

<b>Auto</b>		<b>P/A</b>	<b>Man</b>	
<b>Core</b>			<b>OE#</b>	
<b>Remarks</b> †				

<b>Auto</b>		<b>P/A</b>	<b>Man</b>	
<b>Core</b>			<b>OE#</b>	
<b>Remarks</b> †				

**HOLDEN OPEL VECTRA 1988> 24**

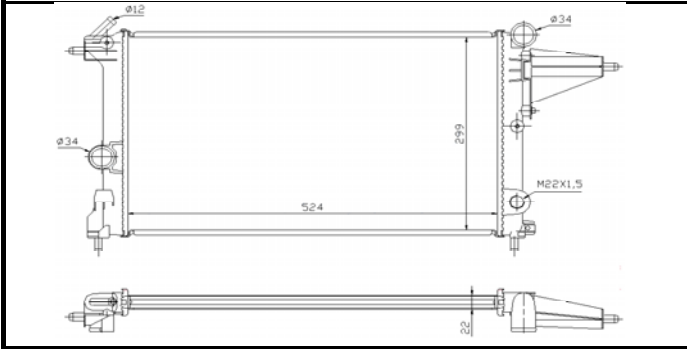

<b>Auto</b>		<b>P/A</b>	<b>Man</b>	HOL24B
<b>Core</b>	525X325X22		<b>OE#</b>	90264491
<b>Remarks</b> † Engine 1.4i 1.6i				

**HOLDEN OPEL COMBO VAN 2000> 21**

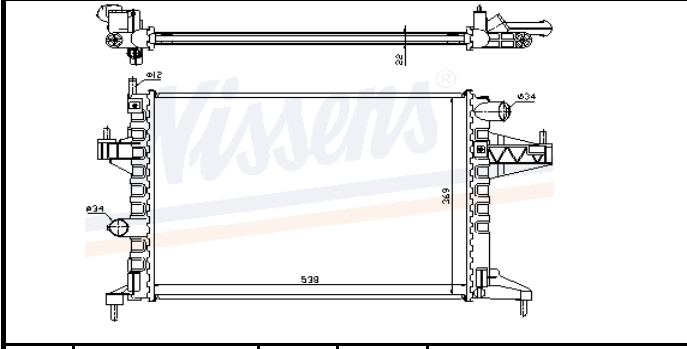

<b>Auto</b>		<b>P/A</b>	<b>Man</b>	HOL21R
<b>Core</b>	540X375X26		<b>OE#</b>	1300237
<b>Remarks</b> †				

<b>Auto</b>		<b>P/A</b>	<b>Man</b>	
<b>Core</b>			<b>OE#</b>	
<b>Remarks</b> †				

<b>Auto</b>		<b>P/A</b>	<b>Man</b>	
<b>Core</b>			<b>OE#</b>	
<b>Remarks</b> †				